

RX UNIV  
(UNIVERZALNA SPRAVA)  
Instrukcije za sklapanje

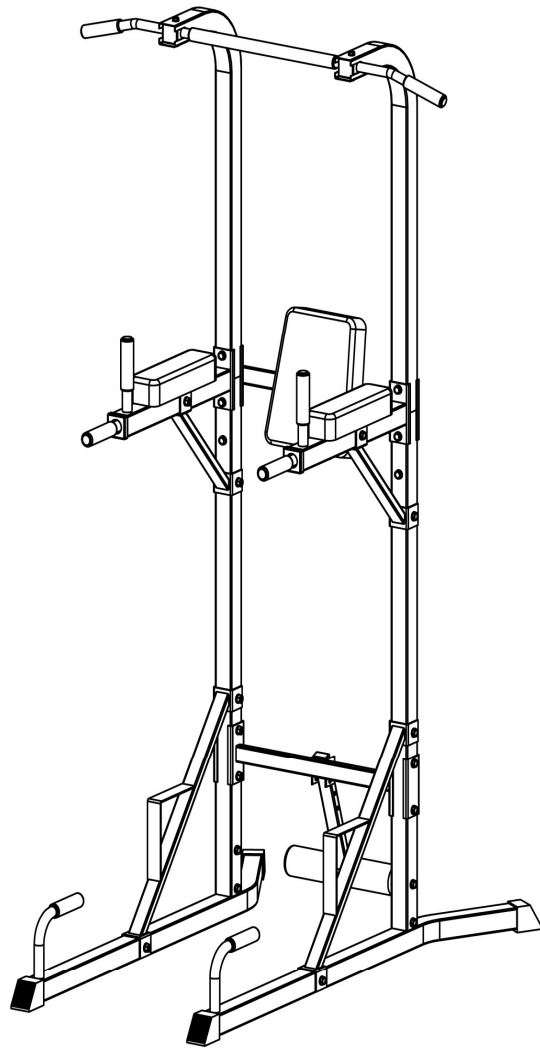

Priručnik za upotrebu

# INSTRUKCIJE ZA SKLAPANJE

## Korak 1

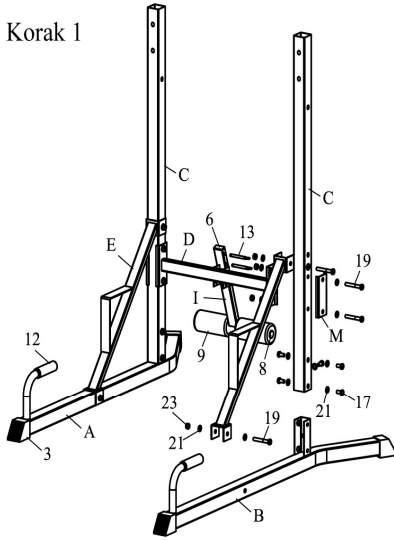

1. Pričvrstite četvrtaste krajnje kapice (3) za levu polugu (A) i desnu polugu (B).
2. Navucite stubove (C) na levu polugu (A) i desnu polugu (B), pritegnite sa deset zavrtnja M10\*20 i deset podloški 10 (21).
3. Pričvrstite horizontalnu potporu (D) i spojnu ploču (M) na stubove (C) sa četiri zavrtnja M10\*70 (19), podloškama 10 (21), kao i navrtkama M10 (23).
4. Pričvrstite dijagonalnu potporu I (E) za levu polugu (A) i stub (C) sa dva zavrtnja M10\*70 (19) i podloškama 10 (21) kao i navrtkama M10 (23).
5. Pričvrstite dijagonalnu potporu I (E) za desnu polugu (A) i stub (C) sa dva zavrtnja M10\*70 (19) i podloškama 10 (21) kao i navrtkama M10 (23).
6. Navucite penaste valjke (9) na penastu potporu (I).
7. Pričvrstite penastu potporu (I) na horizontalnu potporu (D) sa dva osigurača (13).

## Korak 2

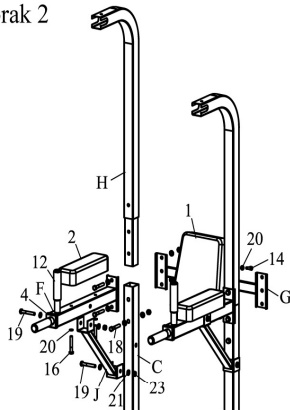





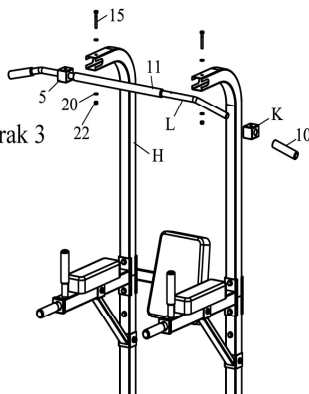



























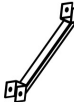

1. Umetnite stubove (H) u stubove (C), zategnite sa zavrtnjima M10\*65 (18) i podloškama 10 (21) kao i navrtkama M10 (23).
2. Pričvrstite plastične jednodielne ležišne posteljice (4) za potpore naslona za ruke (F)
3. Pričvrstite naslone za ruke (2) za potpore naslona ruku (F) sa zavrtnjima M8\*65 (16) i podloškama 8 (20).
4. Pričvrstite potpore naslona ruku (F) i potporu naslona za leđa (G) za stub (C) i stub (H) sa zavrtnjima M10\*70 (19) i podloškama 10 (21) te navrtkama M10 (23).
5. Pričvrstite dijagonalnu potporu II (J) za stubove (C) i potporu naslona ruku (F) sa zavrtnjima M10\*70 (19), i podloškama 10 (21) i navrtkama M10 (23)
6. Pričvrstite naslon za leđa (1) za potporu naslona za leđa (G) sa zavrtnjima M8\*35 (14) i podloškama 8 (20).

## Korak 3



1. Navucite spojnu cev (K) na polugu za izvlačenje (L). Onda navucite penu držača (10) na polugu za izvlačenje (L).
2. Umetnite spojne cevi (K) u stubove (H) i pritegnite sa zavrtnjima M8\*60 (15) podloškama 8 (20) i kontra navrtkama M8 (22).

# Spisak delova

	<u>A-1x</u> Leva poluga		<u>M-2x</u> Spojna ploča		<u>12-4x-Ø25</u> Pena držača
	<u>B-1x</u> Desna poluga		<u>1-1x</u> Potpora za leđa		<u>13-2x</u> Osigurač
	<u>C-2x</u> Stub		<u>2-2x</u> Potpora za ruku		<u>14-2x-M8*35</u> Zavrtnaj
	<u>D-1x</u> Horizontalna potpora		<u>3-4x</u> Četvorostrana krajnja kap		<u>15-2x-M8*60</u> Zavrtnaj
	<u>E-2x</u> Dijagonalna potpora I		<u>4-2x</u> Plastična jednodelna ležišna posteljica		<u>16-4x-M8*65</u> Zavrtnaj
	<u>F-2x</u> Potpora naslona ruke		<u>5-2x-45*45</u> Kvadratna kapa		<u>17-10x-M10*20</u> Zavrtnaj
	<u>G-1x</u> Potpora naslona za leđa		<u>6-1x-40*20</u> Četvrtasta kapa		<u>18-2x-M10*65</u> Zavrtnaj
	<u>H-2x</u> Stub		<u>7-2x-Ø22</u> Okrugla kapa		<u>19-16x-M10*70</u> Zavrtnaj
	<u>I-1x</u> Penasta potpora		<u>8-6x-Ø25</u> Okrugla kapa		<u>20-10x-8</u> Podloška
	<u>J-2x</u> Dijagonalna potpora II		<u>9-2x</u> Penasti valjak		<u>21-46x-10</u> Podloška
	<u>K-2x</u> Spojna cev		<u>10-2x-Ø22</u> Pena držača		<u>22-2x-M8</u> Kontra navrtka
	<u>L-1x</u> Poluga za izvlačenje		<u>11-1x</u> Duga pena		<u>23-18x-M10</u> Navrtka